

Registers

Precharge logic.

Registers

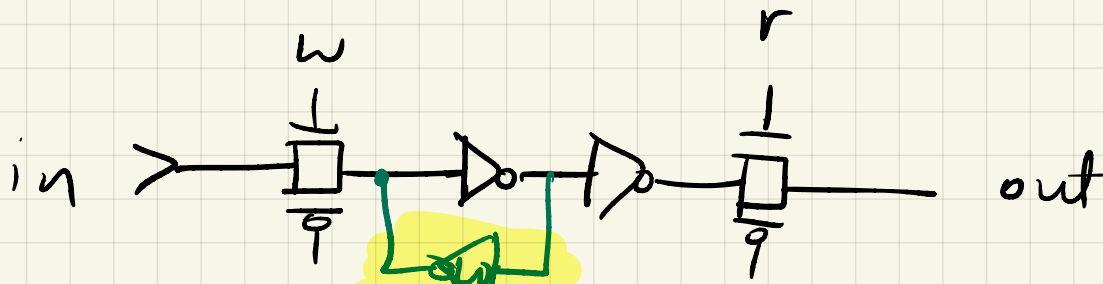
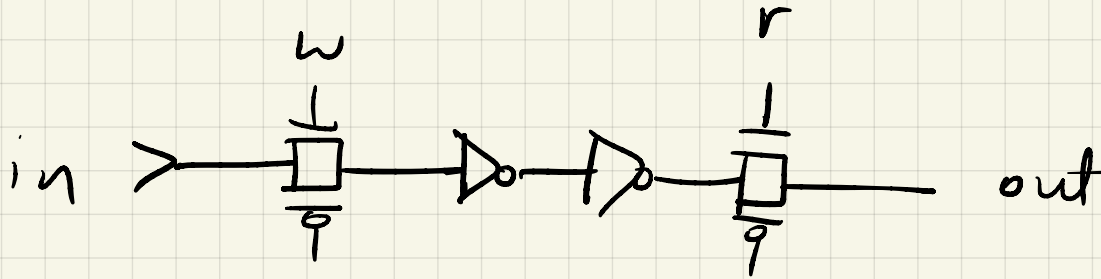
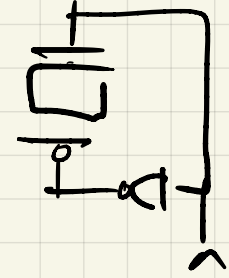
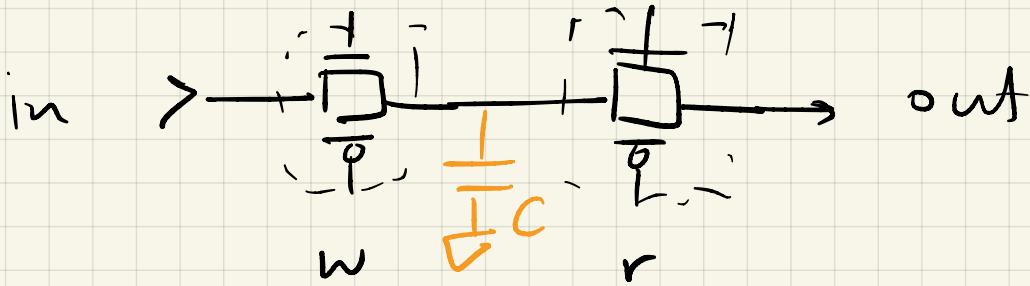

weak feedback

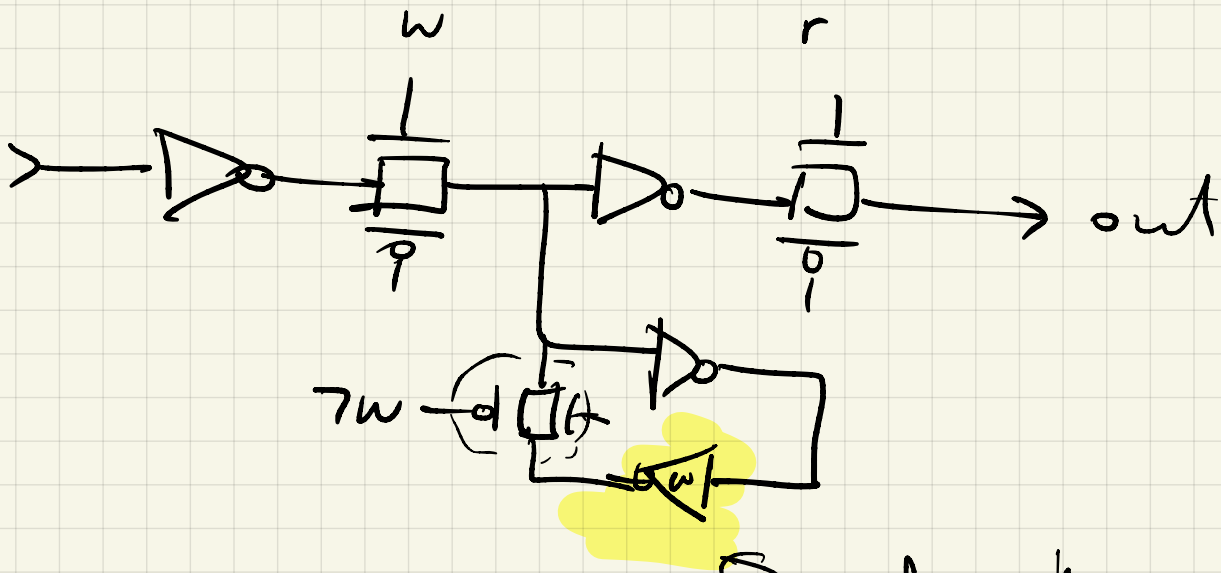
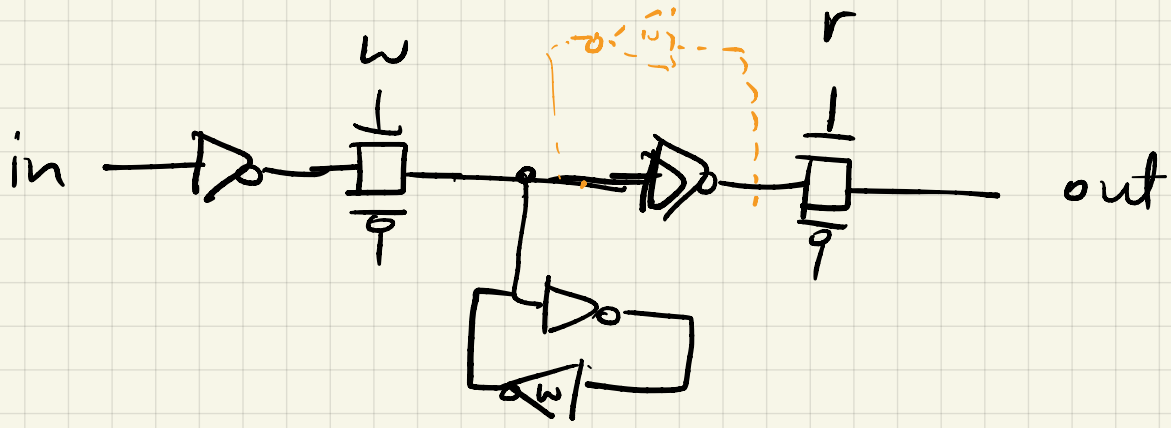

don't
 have to be
 weak any more

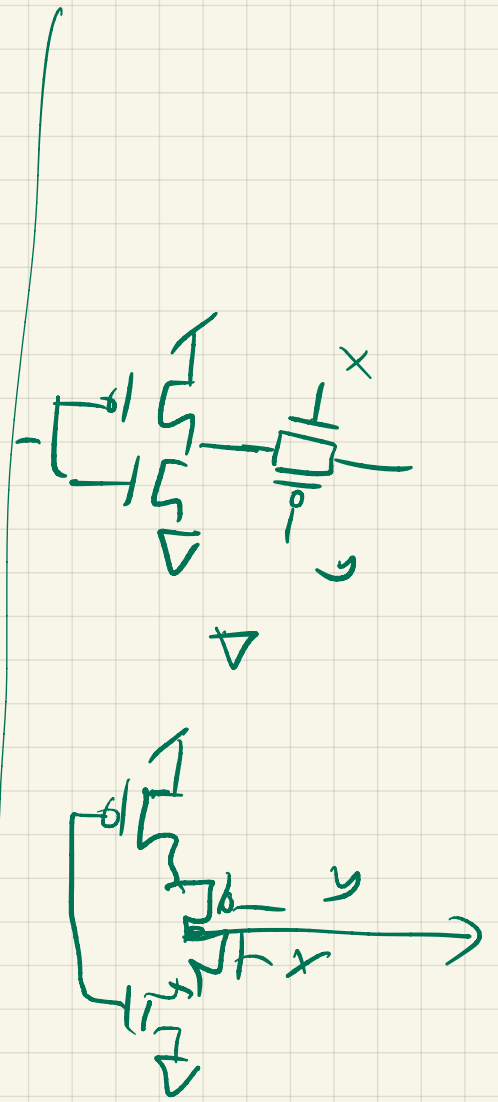

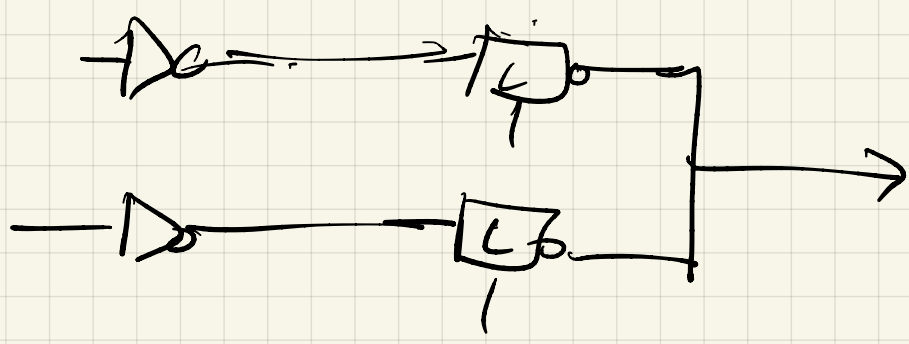
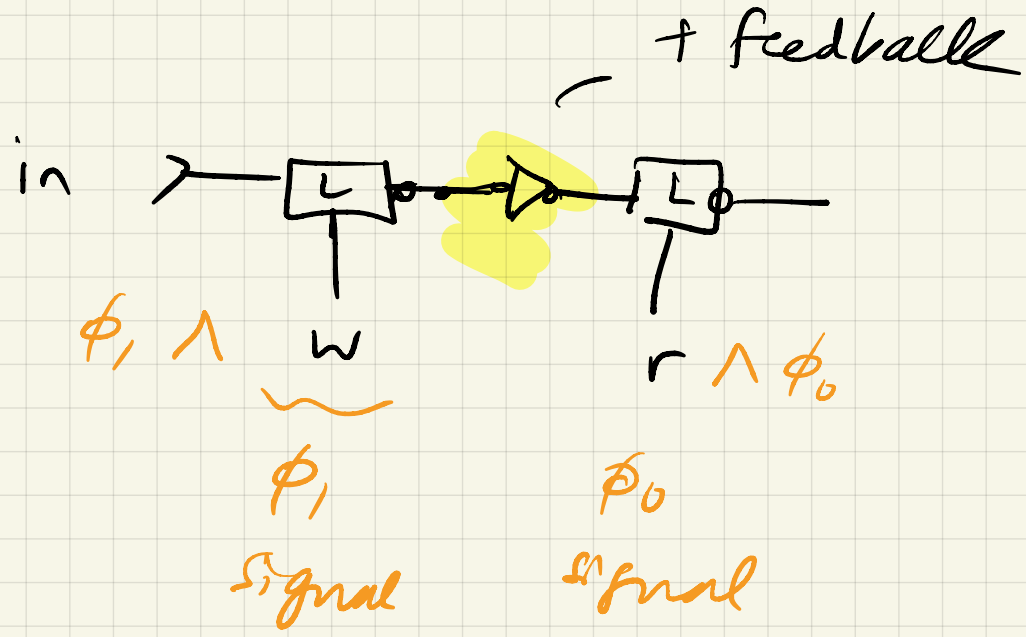

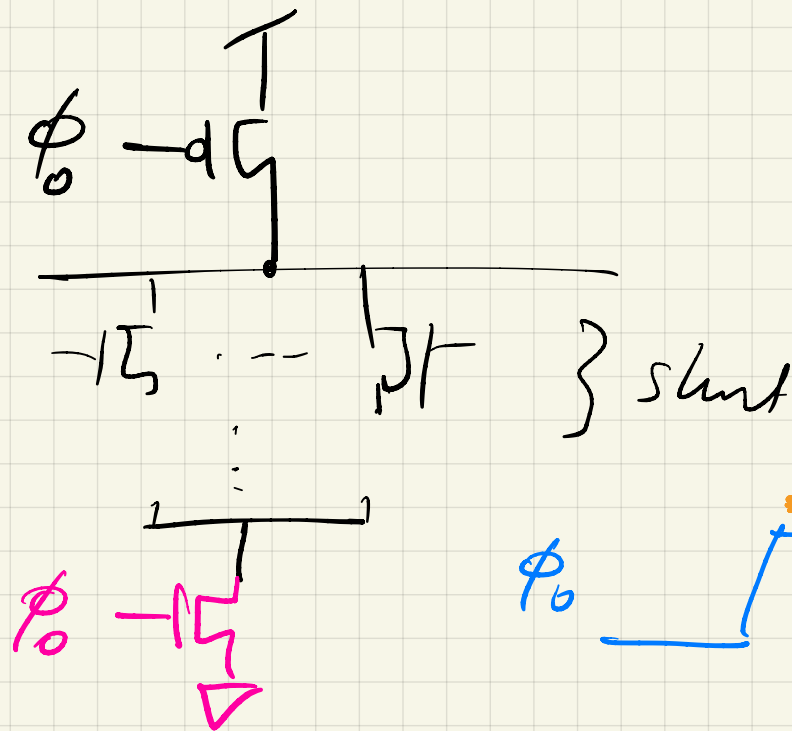
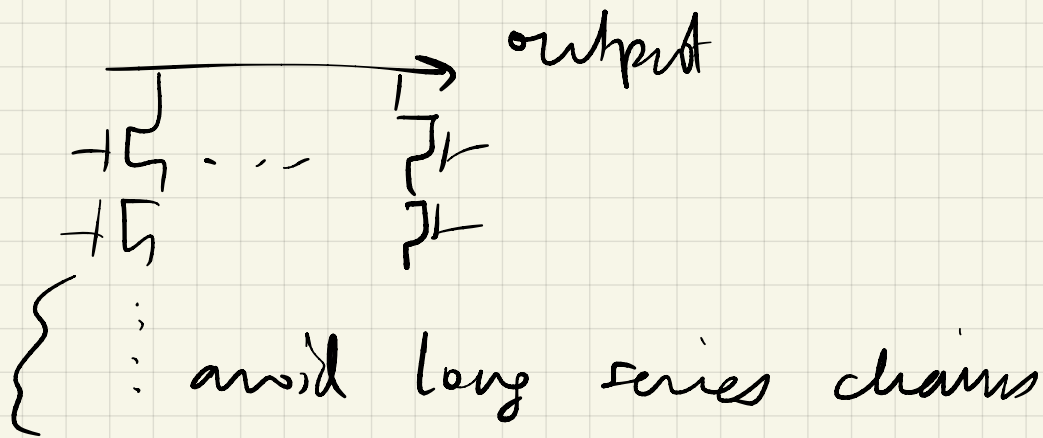

pre-charge

phase: when ϕ_0 is low.

evaluate: when ϕ_0 is high

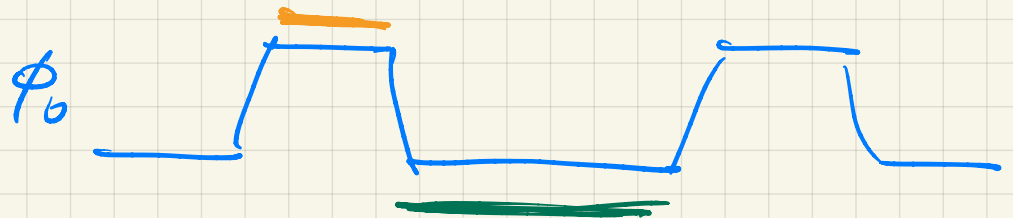

Also:
state-holding

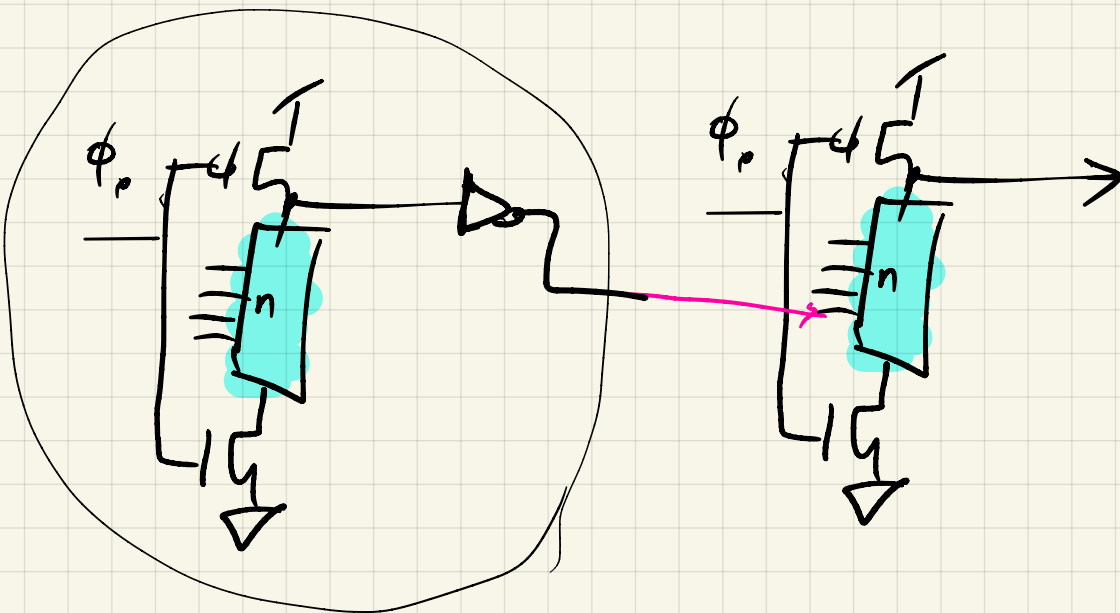
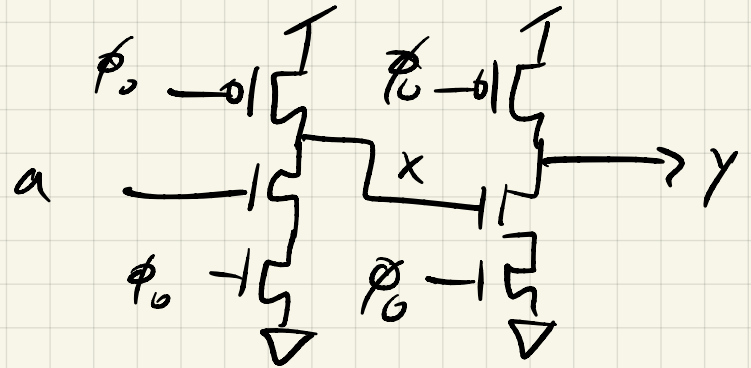
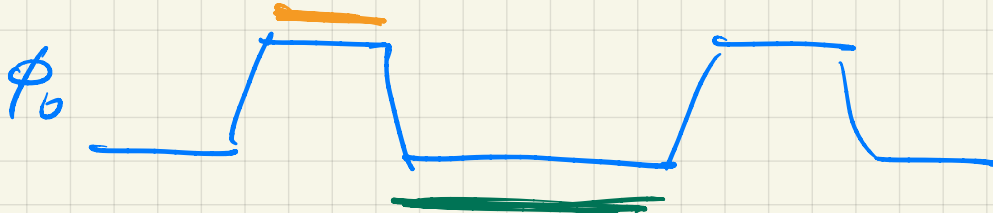
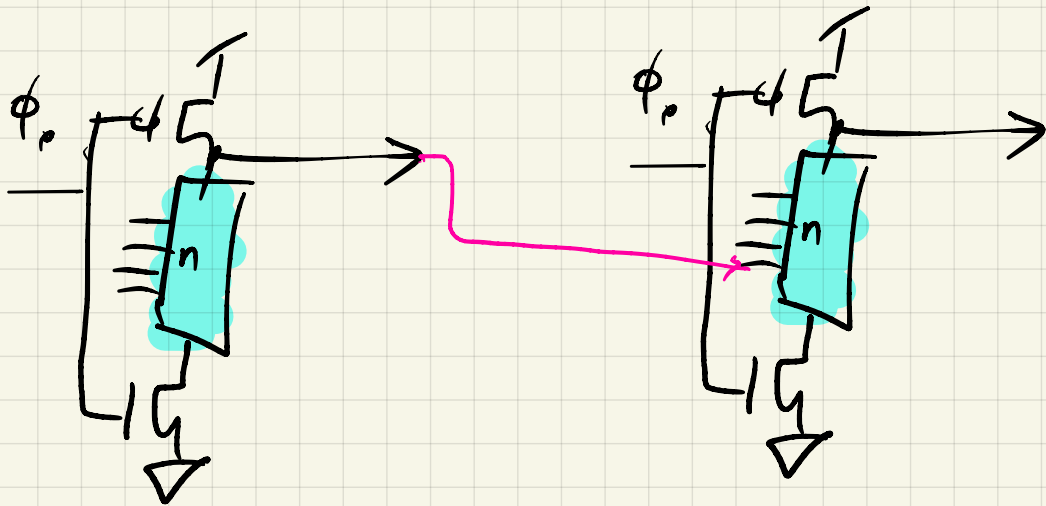

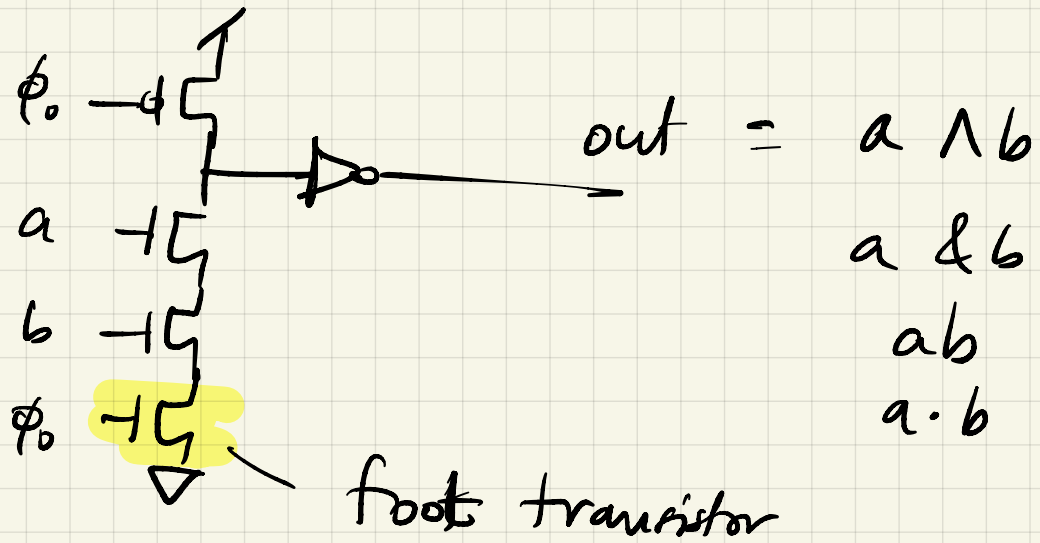

Dual-rail logic

